



HDC Series

- Ratings of 120 A and 160 A @ 48, 72 & 150 VDC
- LED Status Indicator
- Heavy Duty Stud Terminals
- AC or DC control
- Micro Seconds Turn-On and Off times
- Low On-State Voltage Drop
- PWM to 1 kHz for DC Input Models

PRODUCT SELECTION

Control Voltage	120 A	160 A
4.5-32 VDC	HDC60D120, HDC100D120, HDC200D120	HDC60D160, HDC100D160, HDC200D160
90-140 VAC	HDC60A120, HDC100A120, HDC200A120	HDC60A160, HDC100A160, HDC200A160

AVAILABLE OPTIONS

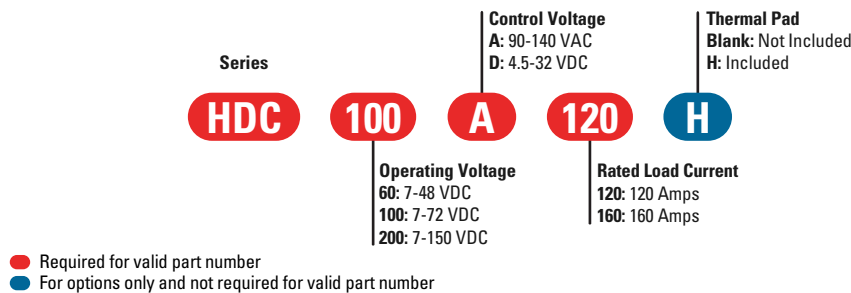

OUTPUT SPECIFICATIONS ⁽¹⁾

Description	HDC60x120	HDC60x160	HDC100x120	HDC100x160	HDC200x120	HDC200x160
Operating Voltage [Vdc]	7-48	7-48	7-72	7-72	7-150	7-150
Blocking Voltage [Vdc]	60	60	100	100	200	200
Rated Load Current [A] ⁽²⁾	120	160	120	160	120	160
Rated Load Current {UL 508 Motor Controller} [FLA]					17 FLA / 2 HP	25 FLA / 3 HP
Rated Load Current {IEC 60947-4-1 DC-1} [Adc] ^(4, 5)	120 (≤ 48 VDC)	160 (≤ 48 VDC)	120 (≤ 72 VDC)	160 (≤ 72 VDC)	120 (≤ 150 VDC)	160 (≤ 150 VDC)
Rated Load Current {IEC 60947-4-1 DC-3} [FLA] ^(4, 5)	17 (≤ 48 VDC)	25 (≤ 48 VDC)	17 (≤ 72 VDC)	25 (≤ 72 VDC)	17 (≤ 150 VDC)	25 (≤ 150 VDC)
Minimum Load Current [mA]	2.5	2.5	2.5	2.5	2.5	2.5
Maximum Surge Current (10ms) [Adc]	360	470	360	470	1200	1600
Maximum Off-State Leakage Current @ Rated Voltage [mA]	0.1	0.1	0.15	0.15	0.2	0.2
Maximum On-State Voltage Drop @ Rated Current [VDC]	0.53	0.56	0.52	0.56	0.72	0.64
Thermal Resistance Junction to Case [Rjc] [°C/W]	0.42	0.36	0.42	0.36	0.25	0.23
Maximum On-State Resistance @ Rated Current (RDS-ON) [mOhms]	4.32	3.5	4.32	3.5	6.0	4.0
Wire Size max (solid/stranded) [AWG/ IEC mm ²]	2/0 / 67.4	2/0 / 67.4	2/0 / 67.4	2/0 / 67.4	2/0 / 67.4	2/0 / 67.4
Output Terminal Nut Torque Range [in lb (Nm)]	225-300 (25.4-33.9)	225-300 (25.4-33.9)	225-300 (25.4-33.9)	225-300 (25.4-33.9)	225-300 (25.4-33.9)	225-300 (25.4-33.9)
Maximum PWM (Hz) ⁽³⁾	1000	1000	1000	1000	1000	1000

INPUT SPECIFICATIONS ⁽¹⁾

Description	HDC60D & HDC100D	HDC60A & HDC100A	HDC200D	HDC200A
Control Voltage Range	4.5-32 VDC	90-140 VAC	4.5-32 VDC	90-140 VAC
Must Turn-Off Voltage	4.2 VDC	35 VAC	4.2 VDC	35 VAC
Minimum Input Current @ Minimum Voltage (for on-state)	23 mA	31 mA	23 mA	31 mA
Maximum Input Current @ Maximum Voltage	45 mA	33 mA	45 mA	33 mA
Nominal Input Impedance	Current Regulated	Current Regulated	Current Regulated	Current Regulated
Maximum Turn-On Time at min voltage	90.5 μs	6 ms	92 μs	6 ms
Maximum Turn-On Time at max voltage	8.5 μs	4 ms	12.0 μs	4 ms
Maximum Turn-Off Time at min voltage	145 μs	9.2 ms	195 μs	9.2 ms
Maximum Turn-Off Time at max voltage	330 μs	9.2 ms	405 μs	9.2 ms
Terminal Type / size in (mm)	QC / 0.187 (4.75)	QC / 0.187 (4.75)	QC / 0.187 (4.75)	QC / 0.187 (4.75)

GENERAL SPECIFICATIONS ⁽¹⁾

Description	Parameters
Dielectric Strength, Input/Output/Base (50/60Hz)	2500 Vrms
Minimum Insulation Resistance (@ 500 VDC)	10 ⁹ Ohm
Maximum Capacitance, Input/Output	10 pF
Ambient Operating Temperature Range ⁽⁶⁾	-30 to 80 °C
Ambient Storage Temperature Range	-40 to 125 °C
Maximum Humidity	85% non-condensing
Weight (typical) lbs/grams	0.75/340.2
Housing Material	PBT 30% GF, UL 94 V-0
SSR Mounting Torque Range [in lbs/Nm]	18-20 (2-2.2)
Baseplate Material	Aluminum
Encapsulation	Thermal Conductive Epoxy
LED Status Indicator (Color)	(green)

MECHANICAL SPECIFICATIONS

Tolerances: ±0.02 in / 0.5 mm
All dimensions are in: inches [millimeters]

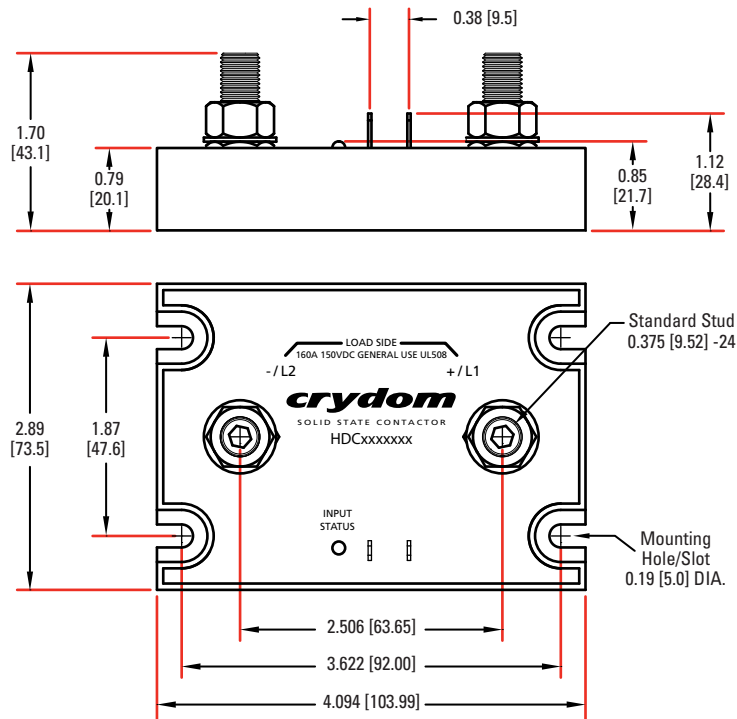

GENERAL NOTES

- (1) All parameters at 25°C unless otherwise specified
- (2) Heat sinking required, see derating curves
- (3) See PWM Derating Chart for DC Input Models Only
- (4) In order to achieve indicated ratings, on HDC60xxx and HDC100xxx series, it is required to connect four varistors in parallel to the output with the following specifications:
Varistor Voltage: 82 V
Energy (2ms): >40 J
- (5) In order to achieve indicated ratings, on HDC200xxx series, it is required to connect two varistors in parallel to the output with the following specifications:
Varistor Voltage: 200 V
Energy (2ms): >100 J
- (6) At 80°C operating temperature, the maximum input voltage for DC versions is 12 VDC

WIRING DIAGRAM

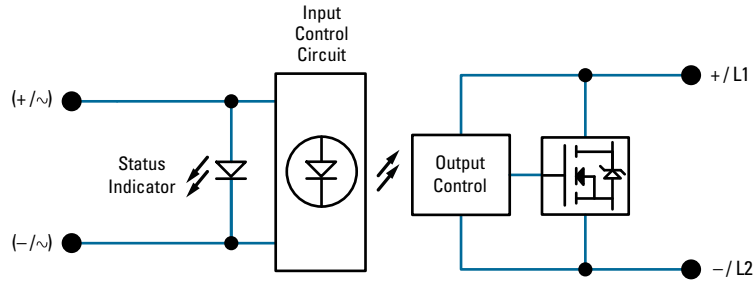

THERMAL DERATE INFORMATION

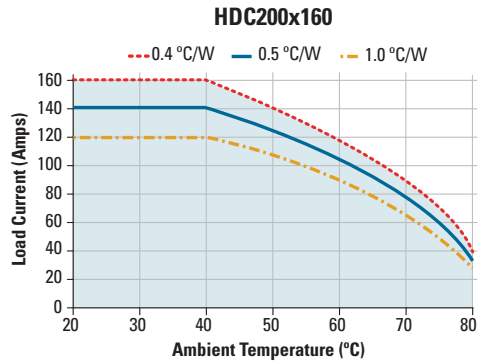
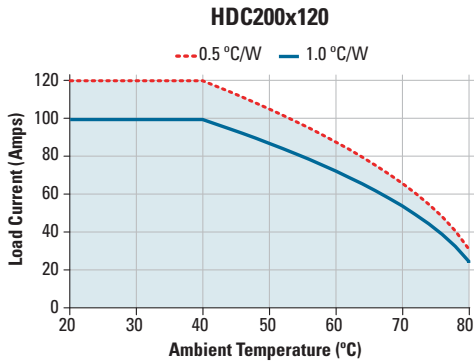
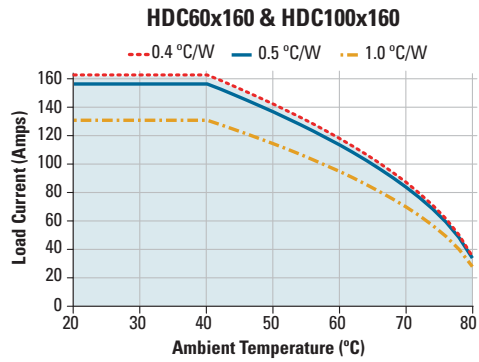
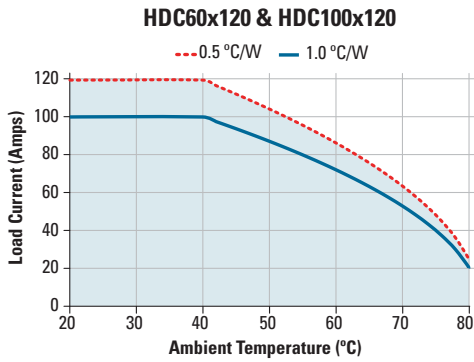

PWM DERATE INFORMATION

HDC60D120 & HDC100D120

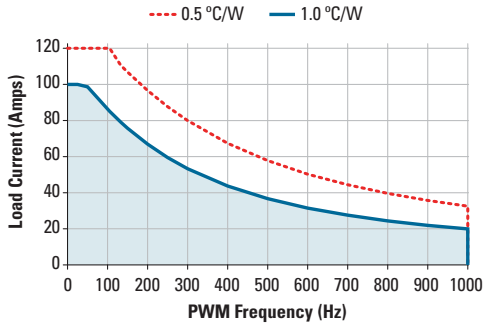

HDC60D160 & HDC100D160

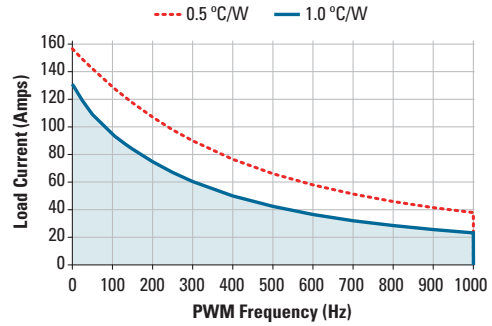

HDC200D120

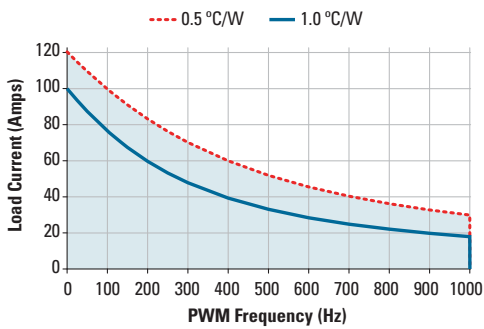

HDC200D160

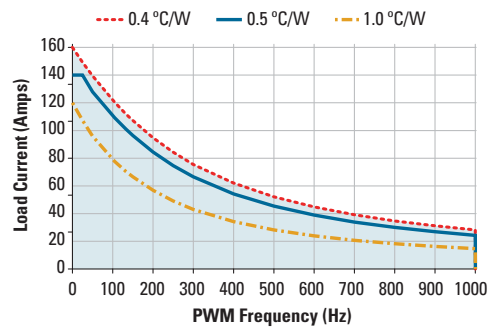





AGENCY APPROVALS

Designed in accordance with the requirements of IEC 62314
 IEC 61000-4-2 : Electrostatic Discharge – Level 3 (Criteria A)
 IEC 61000-4-4 : Electrically Fast Transients – Level 3 (Criteria A)
 IEC 61000-4-5 : Electrical Surges – Level 3 (Criteria A)
 IEC 60068-2-6 : Vibration 0.33mm and 0.75 mm Amplitude over 10-500 Hz
 IEC 60068-2-27 : Shock Resistance 50g/11ms
 IEC60947-4-1 : Contactors and Motor-Starters (DC-1,DC-3)



ACCESSORIES

Recommended Accessories				
				
Hardware Kit	Heat Sink Part No.	Thermal Resistance [°C/W]	Lug Terminal	Thermal Pad
HK1	HS103 / HS103DR	1.0	TRM3/0	HSP-3
	HS053	0.5		HSP-5

Rev. 091316

⚠ DANGER / PELIGRO / DANGER /GEFAHR / PERICOLO / 危險

<p>HAZARD OF ELECTRIC SHOCK, EXPLOSION, OR ARC FLASH.</p> <ul style="list-style-type: none"> • Disconnect all power before installing or working with this equipment. • Verify all connections and replace all covers before turning on power. <p>Failure to follow these instructions will result in death or serious injury.</p>	<p>RIESGO DE DESCARGA ELECTRICA O EXPLOSION.</p> <ul style="list-style-type: none"> • Desconectar todos los suministros de energia a este equipo antes de trabajar con este equipo. • Verificar todas las conexiones y colocar todas las tapas antes de energizar el equipo. <p>El incumplimiento de estas instrucciones puede provocar la muerte o lesiones serias.</p>	<p>RISQUE DE DESCARGE ELECTRIQUE OU EXPLOSION</p> <ul style="list-style-type: none"> • Eteindre toutes les sources d'énergie de cet appareil avant de travailler dessus de cet appareil • Vérifier tous connections, et remettre tous couverts en olace avant de mettre sous <p>De non-suivi de ces instructions provoquera la mort ou des lésions sérieuses.</p>	<p>GEFAHR EINES ELEKTRISCHE N SCHLAGES ODER EINER EXPLOSION.</p> <ul style="list-style-type: none"> • Stellen Sie jeglichen Strom ab, der dieses Gerät versorgt, bevor Sie an dem Gerät Arbeiten durchführen • Vor dem Drehen auf Energie alle Anschlüsse überprüfen und alle Abdeckungen ersetzen. <p>Unterlassung dieser Anweisungen können zum Tode oder zu schweren Verletzungen führen.</p>	<p>RISCHIO DI SCOSSA ELETTRICA O DELL'ESPLOSIONE.</p> <ul style="list-style-type: none"> • Spenga tutta l'alimentazione che fornisce questa apparecchiatura prima di lavorare a questa apparecchiatura • Verificare tutti i collegamenti e sostituire tutte le coperture prima dell'accensione <p>L'omissione di queste istruzioni provocherà la morte o lesioni serie</p>	<p>存在电击、爆炸或电弧闪烁危险</p> <ul style="list-style-type: none"> • 在操作此设备之前请先关闭电源。 <p>若不遵守这些说明,可能会导致严重的人身伤害甚至死亡。</p>
--	--	---	--	--	---

⚠ WARNING / AVERTISSEMENT / WARNUNG /ADVERTENCIA / AVVERTENZA / 警告

<p>RISK OF MATERIAL DAMAGE AND HOT ENCLOSURE</p> <ul style="list-style-type: none"> • The product's side panels may be hot, allow the product to cool before touching. • Follow proper mounting instructions including torque values. • Do not allow liquids or foreign objects to enter this product. <p>Failure to follow these instructions can result in serious injury, or equipment damage.</p>	<p>RISQUE DE DOMMAGE MATERIEL ET DE SURCHAUFFE DU BOITIER</p> <ul style="list-style-type: none"> • Les panneaux latéraux du produit peuvent être chauds. Laisser le produit refroidir avant de le toucher. • Respecter les consignes de montage, et notamment les couples de serrage. • Ne pas laisser pénétrer de liquide ni de corps étrangers à l'intérieur du produit. <p>Le non-respect de cette directive peut entraîner, des lésions corporelles graves ou des dommages matériels.</p>	<p>GEFAHR VON MATERIALSCHÄDEN UND GEHÄUSEERHITZUNG</p> <ul style="list-style-type: none"> • Die Seitenwände können heiß sein. Lassen Sie das Produkt abkühlen, bevor Sie es berühren. • Beachten Sie die Montageanweisungen, • Führen Sie keine Flüssigkeiten oder Fremdkörper in das Produkt ein. <p>Die Nichtbeachtung dieser Anweisung kann Körperverletzung oder Materialschäden zur Folge haben.</p>
<p>RIESGO DE DAÑOS MATERIALES Y DE SOBRECALENTAMIENTO DE LA UNIDAD</p> <ul style="list-style-type: none"> • Los paneles laterales del producto pueden estar calientes. Esperar que el producto se enfríe antes de tocarlo. • Respetar las instrucciones de montaje, y en particular los pares de apretado. • No dejar que penetren líquidos o cuerpos extraños en el producto. <p>Si no se respetan estas precauciones pueden producirse graves lesiones, daños materiales.</p>	<p>RISCHIO DI DANNI MATERIALI E D'INVOLUCRO CALDO</p> <ul style="list-style-type: none"> • I pannelli laterali dell'apparecchio possono scottare; lasciar quindi raffreddare il prodotto prima di toccarlo. • Seguire le istruzioni di montaggio corrette. • Non far entrare liquidi o oggetti estranei in questo apparecchio. <p>La mancata osservanza di questa precauzione può causare gravi rischi per l'incolumità personale o danni alle apparecchiature.</p>	<p>材料损坏和高温外壳的危险性</p> <ul style="list-style-type: none"> • 产品的一侧面板可能很热，在其冷却前请不要触碰。 • 遵照正确的安装说明，包括扭矩值。 • 请勿让液体及其他异物进入本产品。 <p>如不能正确执行这些操作说明,极有可能造成严重人体伤害或者设备的损坏。</p>

ANNEX - ENVIROMENTAL INFORMATION

The environmental information disclosed in this annex including the EIP Pollution logo are in compliance with People’s Republic of China Electronic Industry Standard SJ/T11364 – 2006, Marking for Control of Pollution Caused by Electronic Information Products.

Part Name	Toxic or hazardous Substance and Elements					
	Lead (Pb)	Mercury (Hg)	Cadmium (Cd)	Hexavalent Chromium (Cr (VI))	Polybrominated biphenyls (PBB)	Polybrominated diphenyl ethers (PBDE)
Semiconductor die	X	○	○	○	○	○
Solder	X	○	○	○	○	○

附件 - 环保信息

此附件所标示的包括电子信息产品污染图标的环保信息符合中华人民共和国电子行业标准 SJ/T11364 - 2006, 电子信息产品污染控制标识要求。

部件名称	有毒有害物质或元素					
	铅 (Pb)	汞 (Hg)	镉 (Cd)	六价铬 (Cr (VI))	多溴联苯 (PBB)	多溴二苯醚 (PBDE)
半导体芯片	X	○	○	○	○	○
焊接点	X	○	○	○	○	○



Mouser Electronics

Authorized Distributor

Click to View Pricing, Inventory, Delivery & Lifecycle Information:

Crydom:

[HDC200D120H](#) [HDC200A120](#) [HDC200A120H](#) [HDC200D160](#) [HDC200A160](#) [HDC60D120](#) [HDC60D120H](#)
[HDC60A120](#) [HDC60D160](#) [HDC60A160](#) [HDC100D120H](#) [HDC100A160](#) [HDC200D120](#) [HDC200A160H](#)
[HDC60A120H](#) [HDC100A120H](#) [HDC100D160H](#) [HDC100A160H](#) [HDC60A160H](#) [HDC100D160](#) [HDC60D160H](#)
[HDC100A120](#) [HDC200D160H](#) [HDC100D120](#)